



# Electronic Voting in Belgium Past and Future

---

Danny De Cock  
K.U.Leuven ESAT/COSIC

Slides available from <http://godot.be/slides>



# Outline

- Classic eVoting System
- Interesting things to know
- Requirements for (Belgian) Voting Systems
- Different Voting Channels
- Voting using Magnetic Stripe Cards
- Future eVoting System
- Requirements for Belgian elections
- Organizing elections



# Classic Electronic Voting...

- Introduced in 1991, pilots in 1994, large scale deployment in 1999, currently 44% coverage
- Standalone voting computers – not networked
  - Impossible to cast invalid vote – only valid or blank
  - Open-source software
- Voter uses light pen to select candidates
- Voting ballot encoded on magnetic stripe card
  - Ballot secrecy & integrity through cryptography



# Interesting Things to Know (ITK) 😊

- Different voting channels
  - Belgian citizens abroad
    - Postal vote, paper ballot
    - Voting booth in polling stations
    - Vote by proxy in polling stations
  - Belgians and other citizens in Belgium
    - Paper voting ballot
    - Voting booth for Belgian citizens in polling station
    - Vote by proxy in polling station
    - Online/Internet
- Ballot types
  - Paper ballots
    - Counted manually or automatically
  - Electronic ballots
    - Cast in voting booth
    - Cast online



# Interesting Things to Know (ITK) 😊

- Voting is mandatory in Belgium
  - Everyone strictly older than 17 **must** go to the polling station
  - Sanctions & Fines with respect to ignored voting duty:
    - Police court rules, no appeal possible
    - First offender: 50 Euro
    - Second offense: 125 Euro
    - 4 offenses in less than 15 years: 10 years revocation of
      - Voting rights
      - Right to become a civil servant
      - Possibility to get a promotion or distinction as a civil servant
- 7 Election types → 7 Paper ballot forms 😊
  - European, Federal (Chamber + Senate), Provincial, Regional, Communal, Local Council



# Classic Electronic Polling Station Components

- 589 municipalities
  - 44% of these use voting computers
- One or more polling stations per municipality
- One or more voting offices per polling station
- Each voting office using electronic voting has:
  - 5 or 6 voting booths
  - 1 voting computer per voting booth
  - 1 electronic urn to collect magnetic stripe ballots
  - 1 computer for the president of the voting office
- About 20.000 voting computers in total
  - On average 300 voters per voting computer



# Requirements for (Belgian) Voting Systems

- Universal
  - Everybody can cast a vote
- Equal
  - Everybody has just one vote
- Freedom
  - Everybody can cast his/her vote of his/her choice
- Secrecy
  - Only the voter knows who he has voted for
- Transparency
  - All procedures are simple, publicly available and known
- Verifiability
  - Voting and counting systems are verifiable



# Different Voting Channels

- Uncontrolled environment
  - Pencil + paper
    - Postal vote
  - Electronically
    - Internet voting
- Controlled environment
  - Pencil + paper
    - Voting booths
  - Electronically
    - Offline voting machines
    - Networked voting machines



# Correctness...

- Transparency
  - Voter can/cannot check voting ballot correctness
  - Observer can/cannot check voting ballot correctness
- Auditability
  - Voter can/cannot audit election
  - Observer can/cannot audit election



# Issues – Trustworthiness

- Voting system =
  - Technology + People + Processes
- Paranoia:
  - Does the technology function correctly?
  - Did the voting officials validate the configuration?
  - Is the vote correctly recorded?
  - Is the vote correctly counted?
  - Is the election result correct?
  - Did independent auditors validate the elections?
- Pop quiz:
  - Why would a voting system reflect the voter's choice?



# Comparing (e)Voting Systems

- Paper + Pencil
- Current System (Magnetic Stripe Cards)
- Improved Paper-based Voting

# Real Voting Ballots

ELECTION DE LA CHAMBRE DES REPRESENTANTS  
CIRCONSCRIPTION ELECTORALE DE LA PROVINCE DE LUXEMBOURG  
13 JUIN 2010  
ELECTION DE 4 MEMBRES DE LA CHAMBRE DES REPRESENTANTS

5 PS	6 MR	8 GDH	12 eCOLO	14 R.W.F.	16 ptb+	18 FRONT DES GAUCHES	20 ME PLUS	22 PARTI POPULAIRE	24 WALLONIE d'abord!	25 BELG.UNIE
1 COURARD Philippe ●	1 COLLARD Philippe ●	1 LUTGEN Benoît ●	1 THIBAUT Cécile ●	1 SWIDERSKI Alain ●	1 DULIEU Myriam ●	1 CAHEN Nicole ●	1 CALFANO Olivier ●	1 VANDERBIEST Didier ●	1 LISOT Pascal ●	1 PONCELET Gérard ●
2 BORDI Wronoque ●	2 LAFFIT Anne ●	2 PONCELET Isabelle ●	2 GAUDRON Romain ●	2 LAURENT-HENROTTE Annick ●	2 RASSAA Rafik ●	2 DIEZ Bernard ●	2 LIBOUL Claire ●	2 DESAUX DE MARGNY-PEYCKER Viviane ●	2 GUSSARD Christelle ●	2 BOVY Gilberte ●
3 DAVREUX Anne ●	3 WEBER Marie-Claude ●	3 KRISCH Christiane ●	3 BOIRON Annick ●	3 GENDREBEN DESMET Jean Mathieu ●	3 PASQUIER Françoise ●	3 DEL DEBBIO Vittoria ●	3 CLYX Eric ●	3 CHARLET Luc ●	3 TROMPETTE Jean ●	3 de HEMPTINNE Florence ●
4 STEIFER Francis ●	4 JACQUET André ●	4 BOUCHAT André ●	4 FION François ●	4 WEYER Angélique ●	4 LEXANE Christian ●	4 DONCEEL Michel ●	SUPPLEANTS	4 GERARD Edwige ●	4 LEVEQUE Mélissa ●	4 BALTUS Jean-Marie ●
SUPPLEANTS	SUPPLEANTS	SUPPLEANTS	SUPPLEANTS	SUPPLEANTS	SUPPLEANTS	SUPPLEANTS	1 LIBOUL Claire ●	SUPPLEANTS	SUPPLEANTS	SUPPLEANTS
1 PERPETE André ●	1 PEDROELF Benoît ●	1 ARENS Jony ●	1 PETIT Jérôme ●	1 SWIDERSKI Alain ●	1 ZAMORA Daniel ●	1 BISSEN Bernard ●	2 CLYX Eric ●	1 VANDERBIEST Didier ●	1 GUSSARD Christelle ●	1 CONTER Jo ●
2 HEYDEN Stéphanie ●	2 RASSE Chantal ●	2 MANV Thérèse ●	2 SERVUS Isabelle ●	2 DE CLERCO Odette ●	2 ROEMANS Gertraude ●	2 BLUSTAN Mireille ●	3 CALFANO Olivier ●	2 DESAUX DE MARGNY-PEYCKER Viviane ●	2 BIETHERES Geoffrey ●	2 STRE Marie-Catherine ●
3 WEYRICH Olivier ●	3 BAURY Cédric ●	3 VAN DEN ENDE-CHAPPELLER Annick ●	3 DE FRIEFAU Paul ●	3 DEFAUT Francis ●	3 WILLEMS Mathieu ●	3 DIEZ Frédéric ●	4 FRANCHOLOY Jean ●	3 DARRIELS Arnaud ●	3 LEVEQUE Mélissa ●	3 BEAUDOINT-DAVID Pasalitte ●
4 SONNET Malika ●	4 AUBRY Mélissa ●	4 BALTHAZARD Wronoque ●	4 GOFFIN Annie ●	4 BERTRAND Annick ●	4 VANDAMME Godolève ●	4 EVIARD Jacqueline ●	5 DE ROECK Catharina ●	4 GERARD Edwige ●	4 TROMPETTE Jean ●	4 DELAUNOIS Vincent ●
5 NEUBERG Marie ●	5 NOEL Mariville ●	5 DERLPE Elin ●	5 STILMANT Nicolas ●	5 DELAMITTE Verthe ●	5 HERTOGEN Kristiaan ●	5 ANDRE Nelly ●	6 WARINON Audrey ●	5 CHARLET Luc ●	5 LAMAUT Stéphanie ●	5 NYSSENS Hubert ●
6 PILOT Sébastien ●	6 EVIARD Yves ●	6 FOURNY Damien ●	6 DEWANT Christina ●	6 HERMAN René ●	6 FILLIEUX Guillemine ●	6 HIRMAN Denis ●		6 SORGELOS Annie ●	6 LISOT Pascal ●	6 BOVY Gilberte ●

46cm wide, 24.19cm high  
18.11" x 9.45"



# Real Voting Ballots

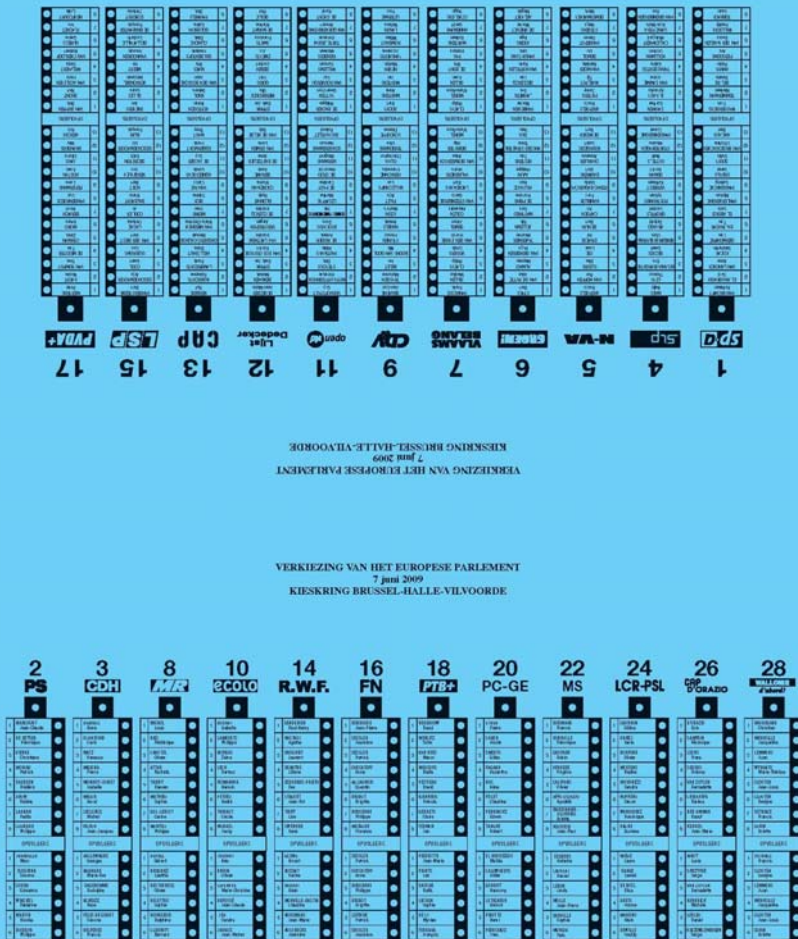

49.54cm wide, 64.07cm high  
19.35" x 25.03"

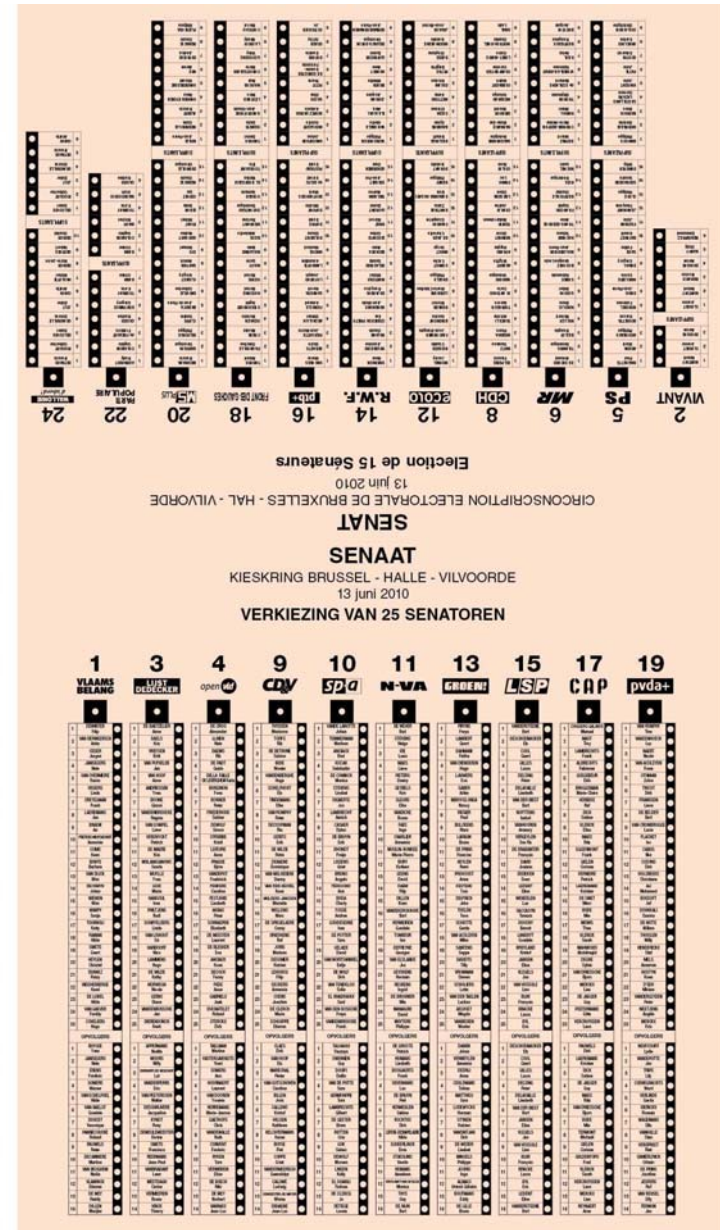

61.3cm wide, 86.68cm high  
23.94" x 33.86"

# 1 Voting Ballot per Election (Chamber, Senate, Regional, European Parliament,...)

Easily 1 meter

Easily 0.5 meter

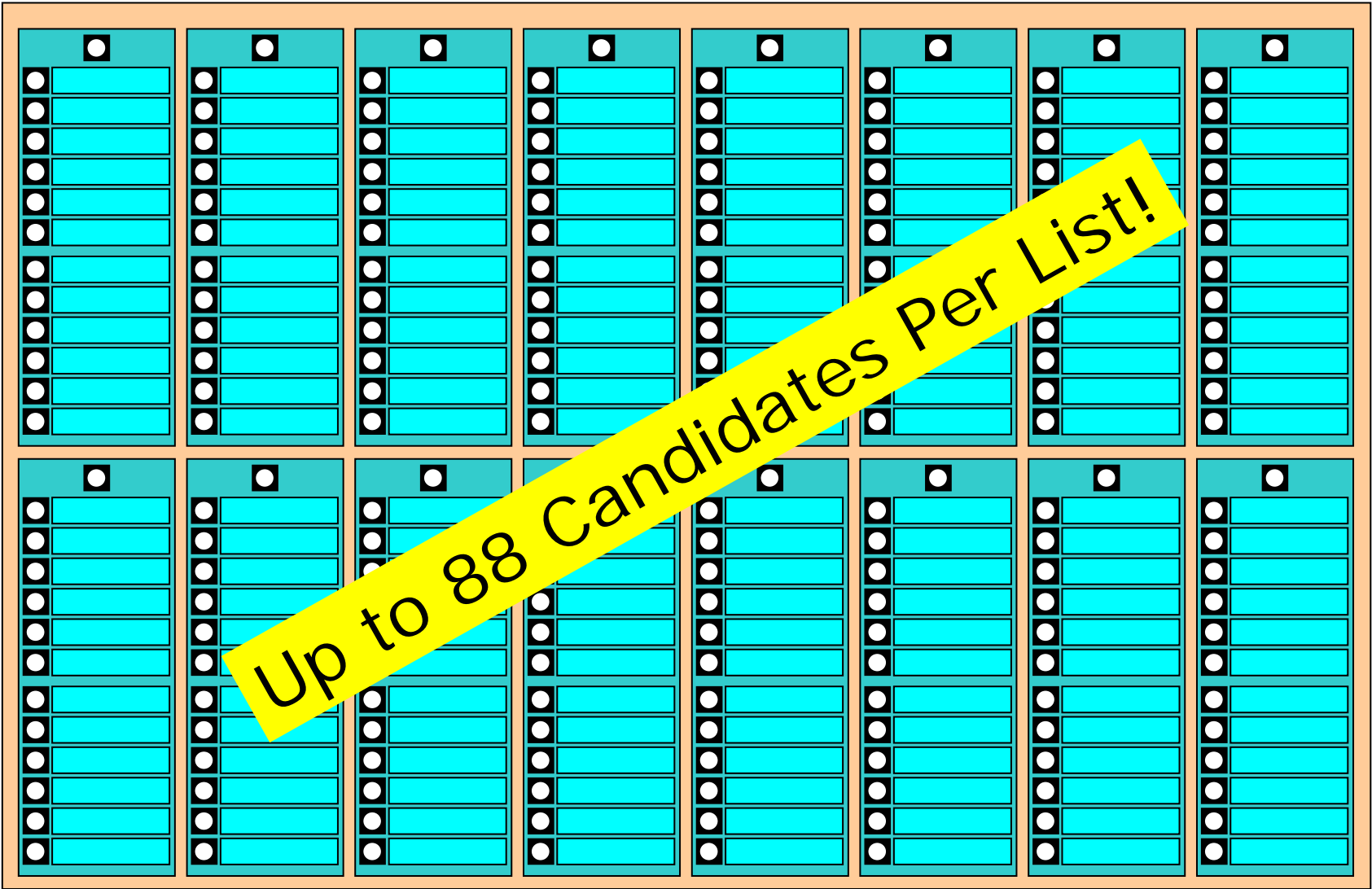

Up to 88 Candidates Per List!

# ITK – Casting a Valid Vote

- Number of elected seats equals number of List votes + number of votes of main candidates + number of votes of successors
- Number of list votes influences the number of elected candidates per list
- A ballot is rendered invalid if a voter ticks candidates of more than one list

<input type="checkbox"/>	
<input type="checkbox"/>	1.
<input type="checkbox"/>	2.
<input type="checkbox"/>	3.
<input type="checkbox"/>	...
<input type="checkbox"/>	
<input type="checkbox"/>	
<input type="checkbox"/>	...
<input type="checkbox"/>	25.
<input type="checkbox"/>	26.
<input type="checkbox"/>	27.
<input type="checkbox"/>	28.
<input type="checkbox"/>	29.

} Voter can tick List Vote

} Voter can also tick any number of main candidates

} Voter can also tick any number of successors



# Electronic Representation of a Voting Ballot

- Candidates are numbered
- Large voting ballot is represented electronically in two menus:
  - Party menu
    - Voter selects his/her party
  - Candidates Menu per party
    - Number of candidates determines the number of columns
    - Voter selects candidates or list
- Note:
  - It is impossible to cast an invalid electronic voting ballot
  - Voter can vote blank by choosing the “Blank party”



# Paper + Pencil

- Cheap
- Simple
  - Everybody understands how it works
  - Not everybody understand potential problems...
- Invalid votes
- Unclear voting ballot marks
- Physical traces on paper: finger prints, scratches, stains,...
- In practice
  - Size of voting ballot in some cantons
  - Preparation, printing and distribution of ballots
  - Counting is cumbersome and slow

# Classic Electronic Voting Booth





# Observations wrt Magnetic Stripe Cards System

- How to convince a voter that the magnetic stripe card corresponds with the voter's choice?
  - Voting computer may have stored a different ballot
- How to convince a voter that his/her vote is read from the magnetic stripe?
  - Voting urn may have overwritten the magnetic stripe

Organizational and procedural measures  
neutralize these potential issues



# Key Arguments to Introduce New System

- Hardware of “current” system is outdated
  - Supply issues
- Countering issues with magnetic stripe cards
- Dependable and verifiable marking of candidates
  - Voter can verify voting ballot
- Secure transport of voting ballots
  - Protection against eavesdropping and modification of ballot storage and transmission
- Counting votes: accurate and fast
  - No need for manual counting
  - Support for recounting
  - Manual audit

# Specified eVoting Booth Components 😊



Printer



Ballot Section	Charter Election	Regional Election	Provincial Election	Regional Election	Local Election
1 First Name	11 First Name	21 First Name	31 First Name	41 First Name	51 First Name
2 Second Name	12 Second Name	22 Second Name	32 Second Name	42 Second Name	52 Second Name
3 Third Name	13 Third Name	23 Third Name	33 Third Name	43 Third Name	53 Third Name
4 Fourth Name	14 Fourth Name	24 Fourth Name	34 Fourth Name	44 Fourth Name	54 Fourth Name
5 Fifth Name	15 Fifth Name	25 Fifth Name	35 Fifth Name	45 Fifth Name	55 Fifth Name
6 Sixth Name	16 Sixth Name	26 Sixth Name	36 Sixth Name	46 Sixth Name	56 Sixth Name
7 Seventh Name	17 Seventh Name	27 Seventh Name	37 Seventh Name	47 Seventh Name	57 Seventh Name
8 Eighth Name	18 Eighth Name	28 Eighth Name	38 Eighth Name	48 Eighth Name	58 Eighth Name
9 Ninth Name	19 Ninth Name	29 Ninth Name	39 Ninth Name	49 Ninth Name	59 Ninth Name
10 Tenth Name	20 Tenth Name	30 Tenth Name	40 Tenth Name	50 Tenth Name	60 Tenth Name
11 Eleventh Name	21 Eleventh Name	31 Eleventh Name	41 Eleventh Name	51 Eleventh Name	61 Eleventh Name
12 Twelfth Name	22 Twelfth Name	32 Twelfth Name	42 Twelfth Name	52 Twelfth Name	62 Twelfth Name
13 Thirteenth Name	23 Thirteenth Name	33 Thirteenth Name	43 Thirteenth Name	53 Thirteenth Name	63 Thirteenth Name
14 Fourteenth Name	24 Fourteenth Name	34 Fourteenth Name	44 Fourteenth Name	54 Fourteenth Name	64 Fourteenth Name
15 Fifteenth Name	25 Fifteenth Name	35 Fifteenth Name	45 Fifteenth Name	55 Fifteenth Name	65 Fifteenth Name
16 Sixteenth Name	26 Sixteenth Name	36 Sixteenth Name	46 Sixteenth Name	56 Sixteenth Name	66 Sixteenth Name
17 Seventeenth Name	27 Seventeenth Name	37 Seventeenth Name	47 Seventeenth Name	57 Seventeenth Name	67 Seventeenth Name
18 Eighteenth Name	28 Eighteenth Name	38 Eighteenth Name	48 Eighteenth Name	58 Eighteenth Name	68 Eighteenth Name
19 Nineteenth Name	29 Nineteenth Name	39 Nineteenth Name	49 Nineteenth Name	59 Nineteenth Name	69 Nineteenth Name
20 Twentieth Name	30 Twentieth Name	40 Twentieth Name	50 Twentieth Name	60 Twentieth Name	70 Twentieth Name



Chip card reader



Optional interface for visually challenged



Mini PC

# Required eVoting Booth Components



Smartcard  
Reader to activate  
Voting process



Simplest  
Computer Possible



Printer

# Specified Voting Ballot

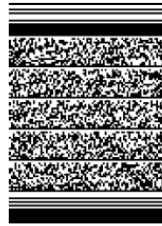

Cast in Leuven

**Check and  
fold this  
ballot**

**Senate Election**  
*Selected Party*

1. First Name
2. Second Name
3. Third Name
4. Fourth Name
5. Fifth Name
6. Sixth Name
7. Seventh Name
8. Eighth Name
9. Ninth Name
10. Tenth Name
11. Eleventh Name
12. Twelfth Name
13. Thirteenth Name
14. Fourteenth Name
15. Fifteenth Name
16. Sixteenth Name

**Chamber Election**  
*Selected Party*

17. First Name
18. Second Name
19. Third Name
20. Fourth Name
21. Fifth Name
22. Sixth Name
23. Seventh Name
24. Eighth Name
25. Ninth Name
26. Tenth Name
27. Eleventh Name
28. Twelfth Name
29. Thirteenth Name
30. Fourteenth Name
31. Fifteenth Name
32. Sixteenth Name

**European Election**  
*Selected Party*

33. First Name
34. Second Name
35. Third Name
36. Fourth Name
37. Fifth Name
38. Sixth Name
39. Seventh Name
40. Eighth Name
41. Ninth Name
42. Tenth Name
43. Eleventh Name
44. Twelfth Name
45. Thirteenth Name
46. Fourteenth Name
47. Fifteenth Name
48. Sixteenth Name

**Province Election**  
*Selected Party*

49. First Name
50. Second Name
51. Third Name
52. Fourth Name
53. Fifth Name
54. Sixth Name
55. Seventh Name
56. Eighth Name
57. Ninth Name
58. Tenth Name
59. Eleventh Name
60. Twelfth Name
61. Thirteenth Name
62. Fourteenth Name
63. Fifteenth Name
64. Sixteenth Name

**Region Election**  
*Selected Party*

65. First Name
66. Second Name
67. Third Name
68. Fourth Name
69. Fifth Name
70. Sixth Name
71. Seventh Name
72. Eighth Name
73. Ninth Name
74. Tenth Name
75. Eleventh Name
76. Twelfth Name
77. Thirteenth Name
78. Fourteenth Name
79. Fifteenth Name
80. Sixteenth Name

**Local Election**  
*Selected Party*

81. First Name
82. Second Name
83. Third Name
84. Fourth Name
85. Fifth Name
86. Sixth Name
87. Seventh Name
88. Eighth Name
89. Ninth Name
90. Tenth Name
91. Eleventh Name
92. Twelfth Name
93. Thirteenth Name
94. Fourteenth Name
95. Fifteenth Name
96. Sixteenth Name



Cast in Leuven

# Specified Voting Office's Equipment

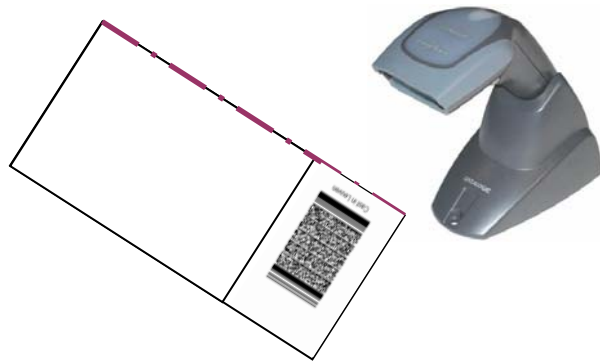

Ballot Verifier

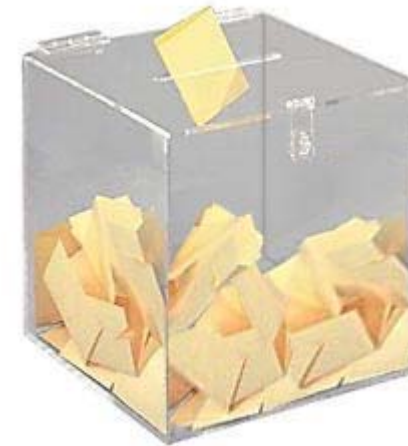

Ballot Box

© George Patton Associates, Inc.



# Voter's Secrecy

- Belgian election system is 'vulnerable' to pattern-based voting
  - Avoid manual processing of ballots
- Voter's fingerprints or marks on paper based ballots
- Cameras in mobile phones, cf. vote selling
- Miniaturized cameras in voting office or booth
- Electromagnetic radiation (TEMPEST)
  - Perfect protection is complicated and expensive
  - Adequate protection is feasible





# Voting in Practice – Voters cast their vote at a Polling Place

## Facts:

1. Voters living in a municipality cast their vote in a voting office
2. Each voting office has a list with eligible voters
3. Each voting office has one voting urn to collect completed voting ballots
4. A voting ballot consists either of a paper ballot or of a magnetic stripe card
5. Election period = 1 Sunday, starting at 9.00
  1. Offices using paper ballots close at 13.00
  2. Offices using magnetic stripe cards close at 15.00

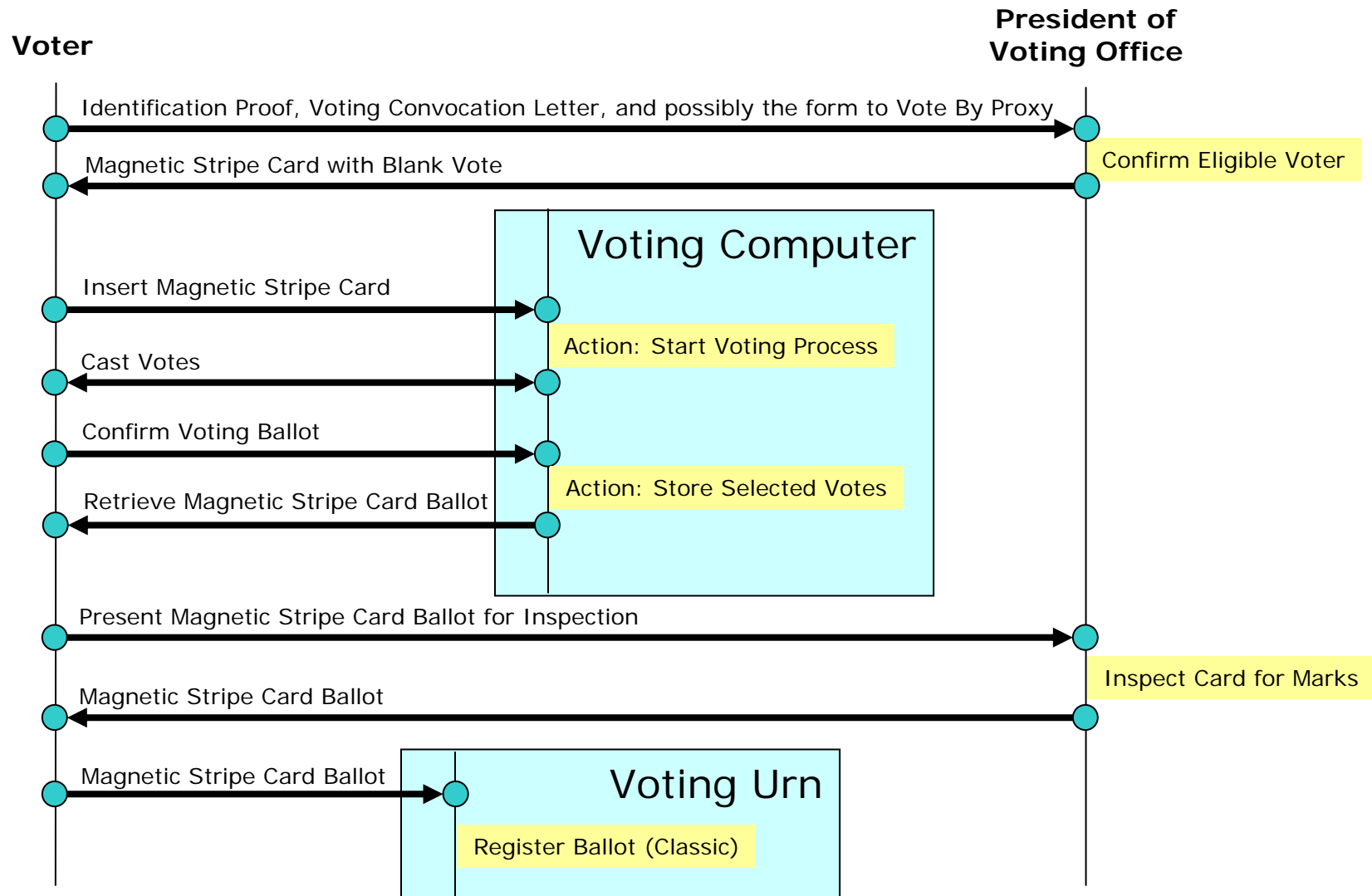
# Voting Procedure – Magnetic Stripe Ballots





# Voting in Practice – Voters cast their Magnetic Stripe Ballot at a Polling Place

## Procedure:

1. Voting officials seal an empty voting urn before first voter arrives
2. Administration broadcasts invitation cards by paper mail to all Belgian citizens who are 18 or older on the Election Day
3. Voter hands over the identity card and invitation card to the voting officials
  - Officials verify identity of the voter
  - Officials check whether the voter is listed on their list with eligible voters
4. Voter receives voting ballot or magnetic stripe card from voting officials
5. Voter casts his/her vote in the voting booth
  - If voter makes a mistake, the president of the voting office may decide to give the voter a second chance
6. Voting official verifies whether the voter did not put a mark on the ballot or magnetic stripe card
  - Marked ballots are invalid
7. Voter inserts the ballot or magnetic stripe card in the voting urn
8. Voting officials stamp the invitation letter to confirm that the voter completed his/her duty
9. Voting officials return identity card and invitation card to voter



# Counting the Magnetic Stripe Ballots

- Paper ballots
  - Seal of the voting urn is removed at the end of the Election Day, e.g., around 14.00
  - Talliers keep tallying at voting office-level until they count twice the same result
- Magnetic stripe cards
  - Voting urn reads magnetic stripe card ballot immediately
    - PC controlling voting urn keeps the score on a floppy
    - All floppies of voting offices are aggregated per municipality at the end of the Election Day
  - Seal of the voting urn with magnetic stripe cards is only removed when recounting is necessary

# Counting New Voting Ballots

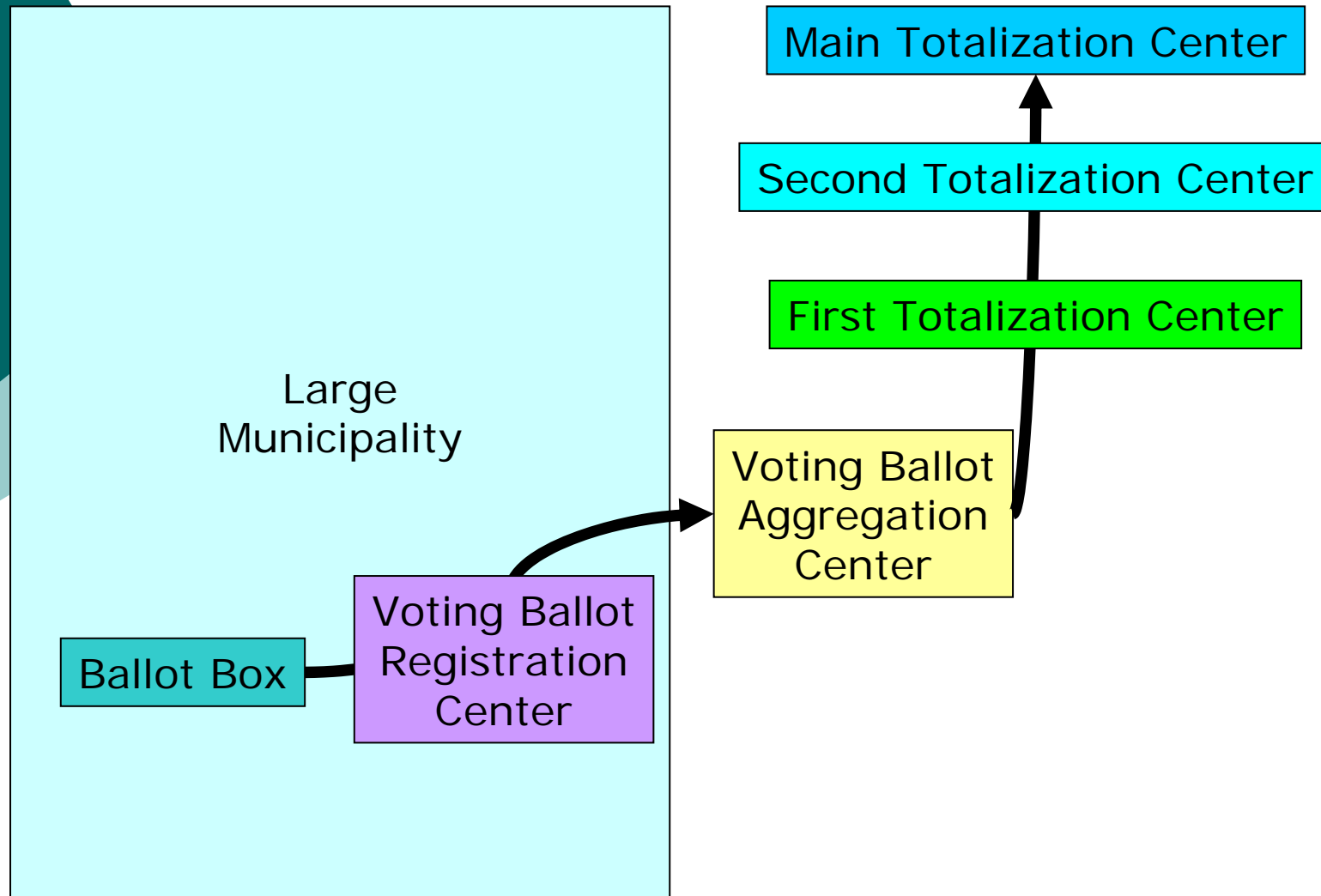

# Counting New Voting Ballots

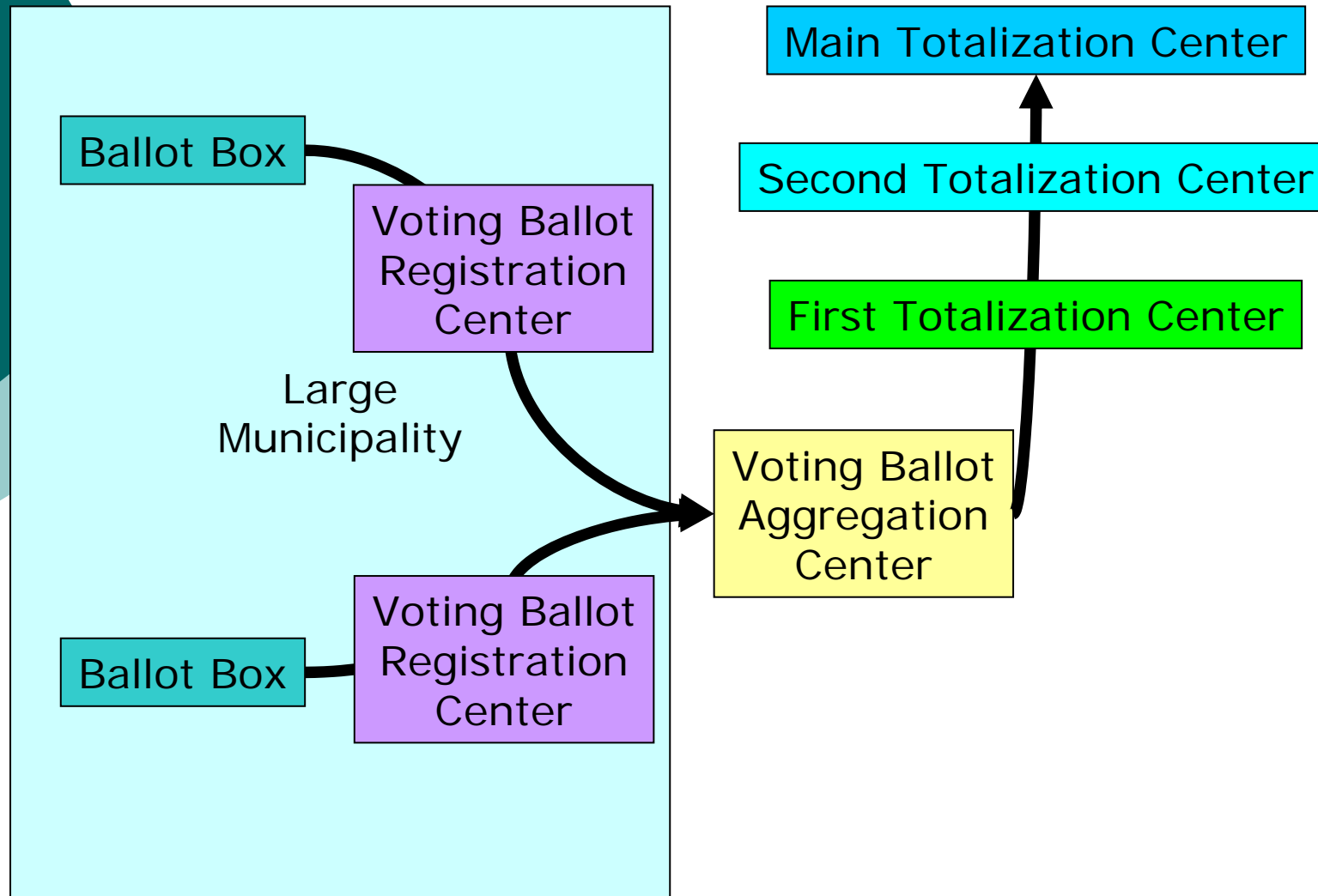

# Counting New Voting Ballots

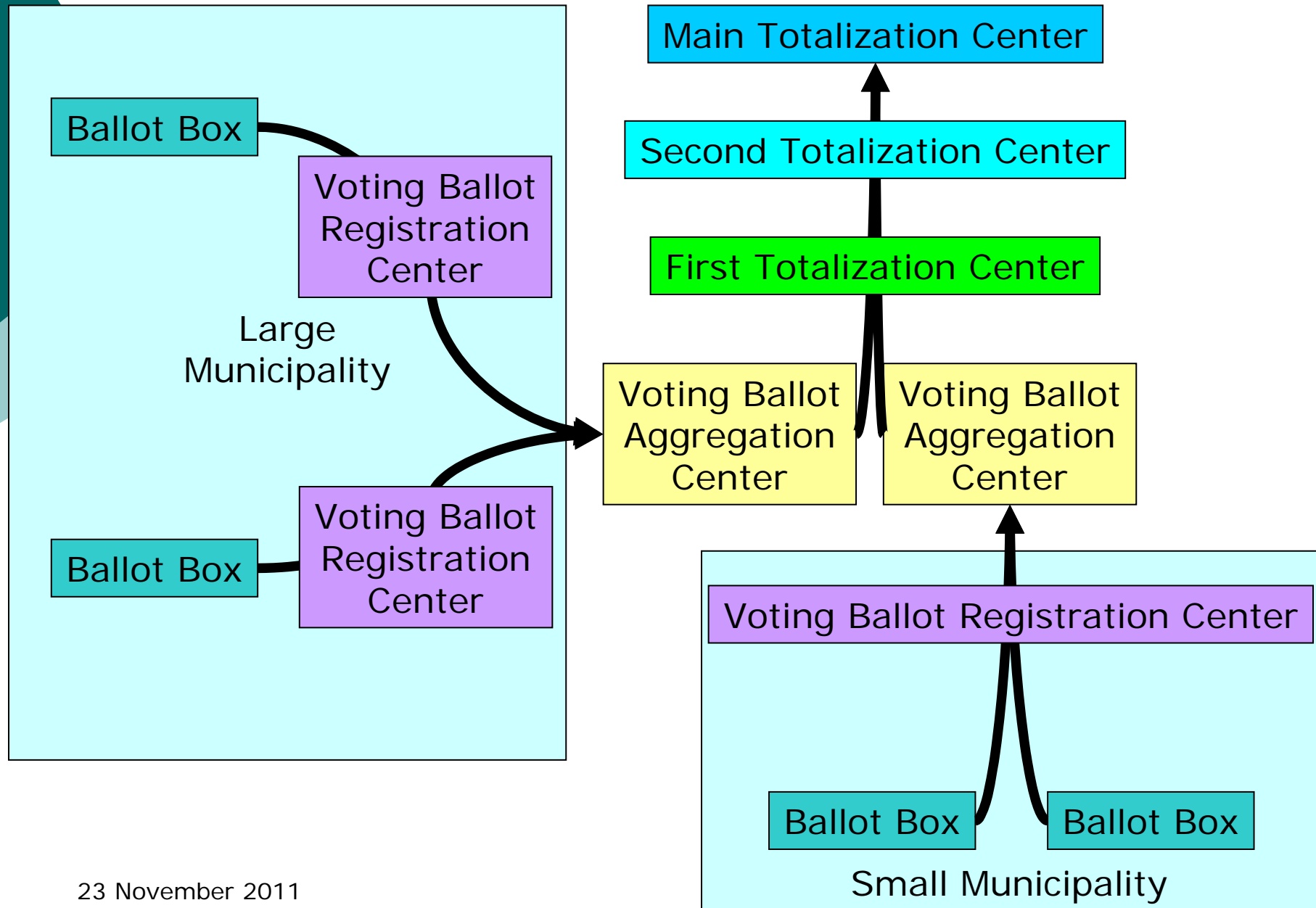

# Counting New Voting Ballots

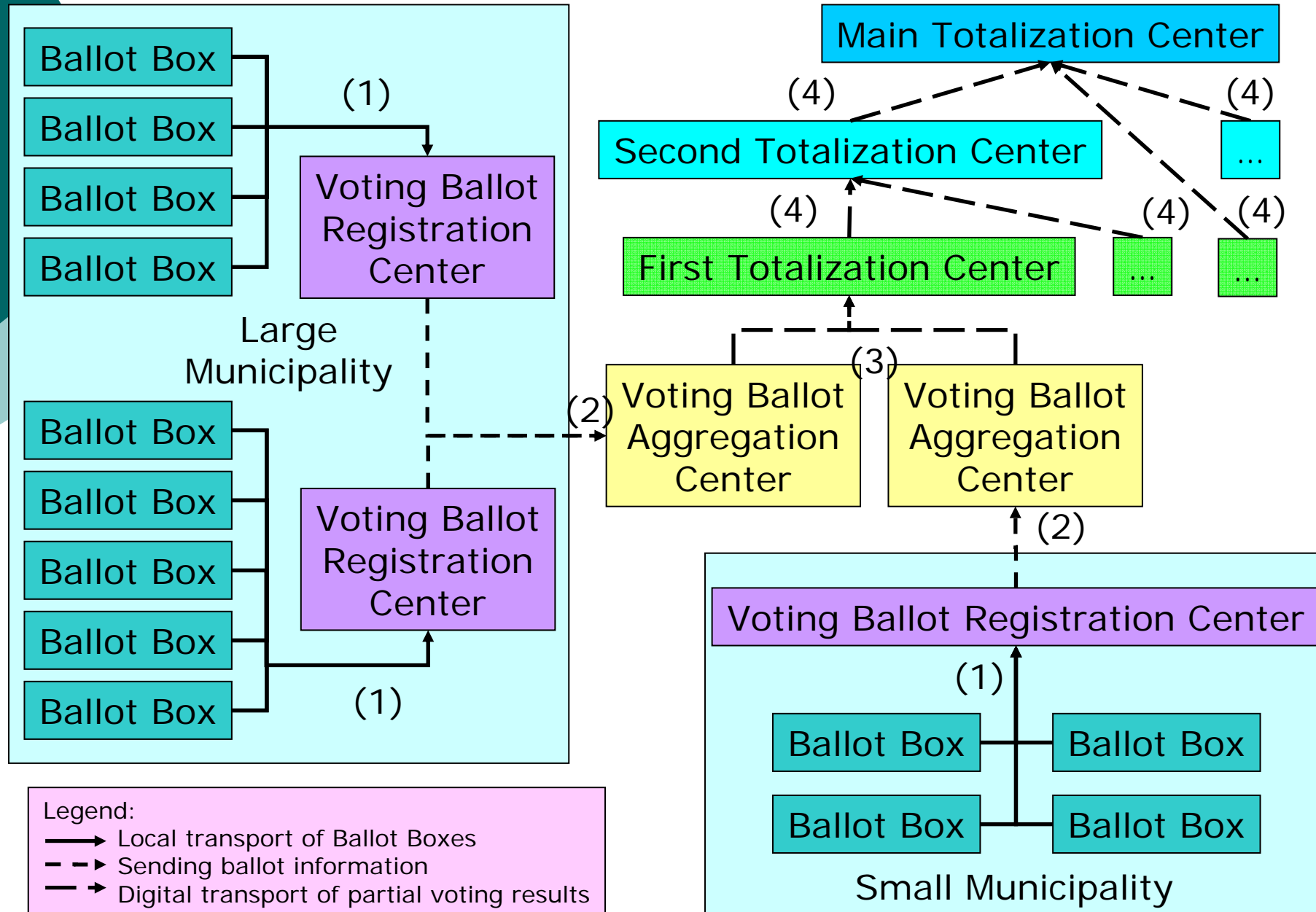



# Processing Election Results

- If a candidate dies before the Election Day
  - The deceased is treated as if he/she never existed
  - Votes for the deceased are taken into account to determine the number of voters for the candidate's list
- If a candidate dies on the Election Day or after the Election Day but before the official announcement of the Election Result
  - The deceased may be elected, but the first successor takes his seat
- If a candidate dies after the official announcement of the Election Result
  - The deceased is replaced by the first successor
- If a candidate dies after closing the candidate list but before printing the paper ballots
  - The list does not include the name of the deceased



# Questions?

- Email:

- [Danny.DeCock@esat.kuleuven.be](mailto:Danny.DeCock@esat.kuleuven.be)
- [godot@godot.be](mailto:godot@godot.be)

- Homepage:

- <http://godot.be>

- Slides:

- <http://godot.be/slides>



# Requirements for Belgian eVoting Systems

- Be combinable with classic paper voting system
- Be usable in the Belgian context
  - Cf. 7 election types, complex ballots...
- Not too expensive
- Available at all times
- Modular & flexible
  - Different voting systems may be used in one canton
  - Installable in voting offices and voting booths
- Customizable
  - List of elections, candidates & parties varies per election
- Easy to verify
  - Correct casting of votes, 1 voter = 1 ballot
  - Correct counting of votes
  - Secrecy of the vote
- Encourage the automated processing of votes
  - Automated casting of votes is less important
- Be very easy to use (user friendliness, simple,...)
- Be very accessible/attractive to
  - Non-computer literate people, elderly, disabled people,...



# Operational Aspects

- D-80: Preparation of lists with eligible voters
- D-40: Independent experts can start auditing the Election procedure
- D-33: Publication of banned acronyms in Belgian Gazette
- D-30: Lottery to rank parties on voting ballots
- D-26: Publication of parties and their numbers in Belgian Gazette
- D-28: Deadline to submit election candidates
- D-24: Fixing lists with election candidates
- D-15: Publishing names of election witnesses, Mail broadcast of election convocation letters
- D-12: Appointing presidents and assistants of voting offices
- D-10: Mail broadcast of lists with eligible voters per voting office
- D- 5: Appointing election witnesses of voting & counting offices
- D- 3: Deadline of voting computer boot floppy delivery to president of cantonal headquarters
- D- 1: President of voting office receives voting ballots, distribution of computer boot floppies to presidents of voting offices
- D : Election day, processing voting ballots after closing election period
- D+15: End of the audit possibility of independent experts
- D+45: Publication of election results
- D+75: Finalization of election-related expenses

# Voting Booth + Barcode voting ballots

2. Use touch screen to mark candidates

3. Print voting ballot



Touch screen with inductive pen

1. Use chip card to activate voting computer



Chip card reader



Mini PC



Optional interface for visually challenged

Local Election	Regional Election	Provincial Election	European Election	Climate Election	Senate Election
1. Local Name	11. Regional Name	21. Provincial Name	31. European Name	41. Climate Name	51. Senate Name
2. Local Name	12. Regional Name	22. Provincial Name	32. European Name	42. Climate Name	52. Senate Name
3. Local Name	13. Regional Name	23. Provincial Name	33. European Name	43. Climate Name	53. Senate Name
4. Local Name	14. Regional Name	24. Provincial Name	34. European Name	44. Climate Name	54. Senate Name
5. Local Name	15. Regional Name	25. Provincial Name	35. European Name	45. Climate Name	55. Senate Name
6. Local Name	16. Regional Name	26. Provincial Name	36. European Name	46. Climate Name	56. Senate Name
7. Local Name	17. Regional Name	27. Provincial Name	37. European Name	47. Climate Name	57. Senate Name
8. Local Name	18. Regional Name	28. Provincial Name	38. European Name	48. Climate Name	58. Senate Name
9. Local Name	19. Regional Name	29. Provincial Name	39. European Name	49. Climate Name	59. Senate Name
10. Local Name	20. Regional Name	30. Provincial Name	40. European Name	50. Climate Name	60. Senate Name